



INSTRUCTION MANUAL

IP ADVANCED RADIO SYSTEM
COMMUNICATION TERMINAL

IP100H



TABLE OF CONTENTS

Section 1 ACCESSORY ATTACHMENT	1-1	Section 5 OTHER FUNCTIONS	5-1
External antenna	1-2	Pocket beep function	5-2
Antenna connector cap	1-2	P-Bell function.....	5-2
Battery pack	1-3	About the [Option] switch	5-2
Belt clip.....	1-3	Section 6 OPTIONS	6-1
Hand strap	1-3	Option list.....	6-2
Section 2 BATTERY CHARGING	2-1	◇ Battery packs/case	6-2
Battery pack cautions	2-2	◇ Battery chargers.....	6-2
◇ Battery caution	2-2	◇ Others	6-2
◇ Charging caution	2-3	◇ Headset/Microphones	6-2
◇ Charging time (Approximately)	2-3	Connection	6-3
Using the BC-202	2-4	◇ Connectable options	6-3
Using the BC-211	2-4	Section 7 FOR YOUR REFERENCE	7-1
Battery status indicator	2-5	Troubleshooting	7-2
◇ Battery warning beeps	2-5	Specifications	7-3
Battery life	2-5	◇ IP100H	7-3
Battery case	2-6	◇ BC-202 DESKTOP CHARGER	7-3
Section 3 BASIC OPERATION	3-1	◇ BC-211 MULTI-CHARGER	7-3
Turning ON the power	3-2		
Adjust audio level	3-2		
Key lock function	3-3		
Section 4 CALLING OPERATION	4-1		
Calling procedures outline	4-2		
Selecting address books, and addresses (ID)	4-3		
Selecting messages or statuses	4-4		
Voice communication.....	4-5		
◇ Individual call	4-5		
◇ All call	4-5		
◇ Group call	4-5		
◇ Telephone call.....	4-5		
Message Call	4-6		
◇ To an individual terminal	4-6		
◇ To all terminals	4-6		
◇ To a Group	4-6		
Using a call history.....	4-7		
Status Call	4-8		
Erasing all log items	4-8		
Area Call function	4-9		

Section 1 ACCESSORY ATTACHMENT

External antenna.....	1-2
Antenna connector cap.....	1-2
Battery pack.....	1-3
Belt clip.....	1-3
Hand strap.....	1-3

External antenna



When the External antenna is selected,* connect the supplied flexible antenna to the antenna connector.

CAUTION:

- **NEVER** carry the communication terminal by holding only the antenna.
- Transmitting without an antenna may damage the internal circuit.

Antenna connector cap

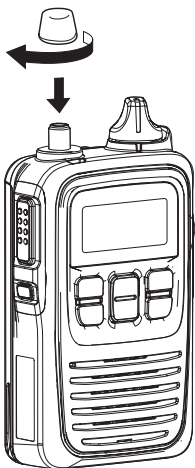

When the Internal antenna is selected,* connect the supplied antenna connector cap to the antenna connector.

*The antenna is selected in your IP1000C system controller.

For your information

The communication range will differ between the External and Internal antennas.

See the table below for reference.

Frequency band	Internal antenna	External antenna
2.4 GHz band	90 m (295 ft)	160 m (525 ft)
5 GHz band		190 m (623 ft)

Approximate range

Battery pack

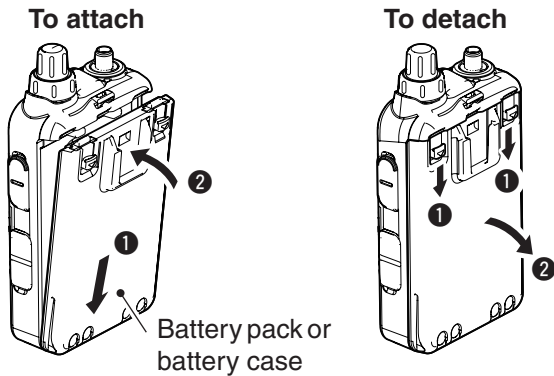

To attach or detach the battery pack:

To attach or detach the battery pack or battery case, follow the illustrations to the left.

Even when the communication terminal power is OFF, a small current still flows in the communication terminal. Remove the battery pack or case when not using it for a long time. Otherwise, the batteries will become exhausted.

Belt clip

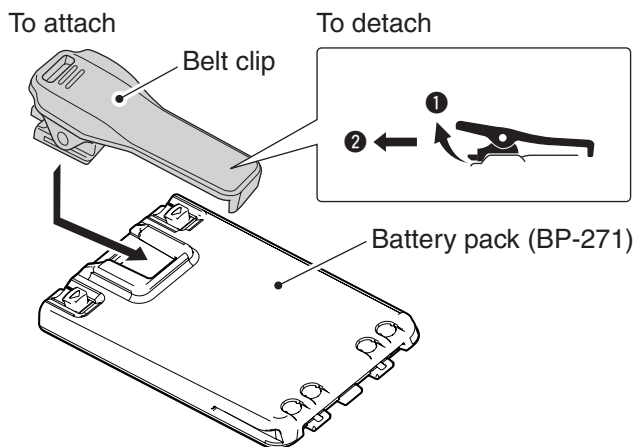

To attach the belt clip:

- ① Remove the battery pack from the communication terminal, if it is attached.
- ② Slide the belt clip in the direction of the arrow until the belt clip locks in place, and makes a 'click' sound.

To detach the belt clip:

- ① Remove the battery pack from the communication terminal, if it is attached.
- ② Lift the tab up (①), and slide the belt clip in the direction of the arrow (②).

Hand strap

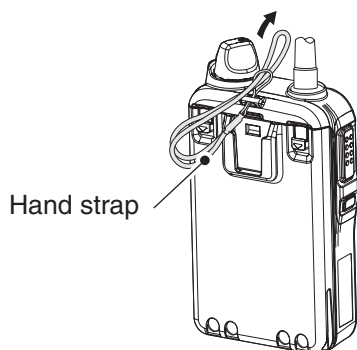

To facilitate carrying the communication terminal, slide the hand strap through the loop on the top of the rear panel, as illustrated to the left.

Section 2

BATTERY CHARGING

Battery pack cautions	2-2
◇ Battery cautions	2-2
◇ Charging caution	2-3
◇ Charging time (Approximate)	2-3
Using the BC-202	2-4
Using the BC-211	2-4
Battery status indicator	2-5
◇ Battery warning beeps	2-5
Battery life	2-5
Battery case	2-6

Battery pack cautions

⚠ DANGER! NEVER short the terminals (or charging terminals) of the battery pack. Also, current may flow into nearby metal objects such as a key, so be careful when placing battery packs (or the communication terminal) in bags, etc. Simply carrying with or placing near metal objects may cause shorting. This may damage not only the battery pack, but also the communication terminal.

⚠ DANGER! Use and charge only specified Icom battery packs with Icom terminals or Icom chargers. Only Icom battery packs are tested and approved for use with Icom terminals or charged with Icom chargers. Using third-party or counterfeit battery packs may cause smoke, fire, or cause the battery pack to burst.

◇ Battery cautions

⚠ DANGER! DO NOT hammer or otherwise impact the battery pack. Do not use the battery pack if it has been severely impacted or dropped, or if the battery pack has been subjected to heavy pressure. Battery damage may not be visible on the outside of the case. Even if the surface of the battery pack does not show cracks or any other damage, the cells inside the battery pack may rupture or catch fire.

⚠ DANGER! NEVER use or leave battery pack in areas with temperatures above +60°C (+140°F). High temperature buildup in the battery, such as could occur near fires or stoves, inside a sun heated car, or in direct sunlight may cause the battery pack to rupture or catch fire. Excessive temperatures may also degrade battery performance or shorten battery life.

⚠ DANGER! DO NOT expose the battery pack to rain, snow, seawater, or any other liquids. Do not charge or use a wet battery pack. If the battery pack gets wet, be sure to wipe it dry before using.

⚠ DANGER! NEVER incinerate a used battery pack since internal battery gas may cause it to rupture, or may cause an explosion.

⚠ DANGER! NEVER solder the battery terminals, or NEVER modify the battery pack. This may cause heat generation, and the battery pack may burst, emit smoke or catch fire.

⚠ DANGER! Use the battery pack only with the communication terminal for which it is specified. Never use a battery pack with any other equipment, or for any purpose that is not specified in this instruction manual.

⚠ DANGER! If fluid from inside the battery gets in your eyes, blindness can result. Rinse your eyes with clean water, without rubbing them, and see a doctor immediately.

⚠ WARNING! Immediately stop using the battery if it emits an abnormal odor, heats up, or is discolored or deformed. If any of these conditions occur, contact your Icom dealer or distributor.

⚠ WARNING! Immediately wash, using clean water, any part of the body that comes into contact with fluid from inside the battery.

⚠ WARNING! NEVER put the battery pack in a microwave oven, high-pressure container, or in an induction heating cooker. This could cause a fire, overheating, or cause the battery pack to rupture.

CAUTION: Always use the battery pack within the specified temperature range, -20°C to +60°C (-4°F to +140°F). Using the battery pack out of its specified temperature range will reduce the battery's performance and battery life.

CAUTION: Shorter battery life could occur if the battery pack is left fully charged, completely discharged, or in an excessive temperature environment (above +50°C; +122°F) for an extended period of time. If the battery pack must be left unused for a long time, it must be detached from the terminal after discharging. You may use the battery pack until the battery indicator shows half capacity, then keep it safely in a cool dry place at the following temperature range:

- 20°C (-4°F) to +50°C (+122°F) (within a month)
- 20°C (-4°F) to +35°C (+95°F) (within three months)
- 20°C (-4°F) to +20°C (+68°F) (within a year)

BE SURE to replace the battery pack with a new one after five years, even if still holds a charge. The material inside the battery will deteriorate after a period of time, even with little use.

Battery pack cautions (continued)

◇ Charging caution

⚠ **DANGER! NEVER** charge the battery pack in areas with extremely high temperatures, such as near fires or stoves, inside a sun-heated vehicle, or in direct sunlight. In such environments, the safety/protection circuit in the battery pack will activate, causing the battery pack to stop charging.

⚠ **WARNING! NEVER** charge or leave the battery pack in the battery charger beyond the specified time for charging. If the battery pack is not completely charged by the specified time, stop charging and remove the battery pack from the battery charger. Continuing to charge the battery pack beyond the specified time limit may cause a fire, overheating, or the battery pack may rupture.

⚠ **WARNING! NEVER** insert the communication terminal (with battery pack) into the charger if it is wet or soiled. This could corrode the battery charger terminals or damage the charger. The charger is not waterproof.

CAUTION: DO NOT charge the battery pack outside of the specified temperature range:

BC-202: ±0°C to +40°C (+32°F to +104°F)

BC-211: +10°C to +40°C (+50°F to +104°F)

Icom recommends charging the battery pack at +25°C (+77°F). The battery pack may heat up or rupture if charged out of the specified temperature range. Additionally, battery performance or battery life may be reduced.

◇ Charging time

(Approximate)

Charger Battery pack	BC-202	BC-211
BP-271	2 hours	2 hours
BP-272	3.5 hours	3.5 hours

Using the BC-202

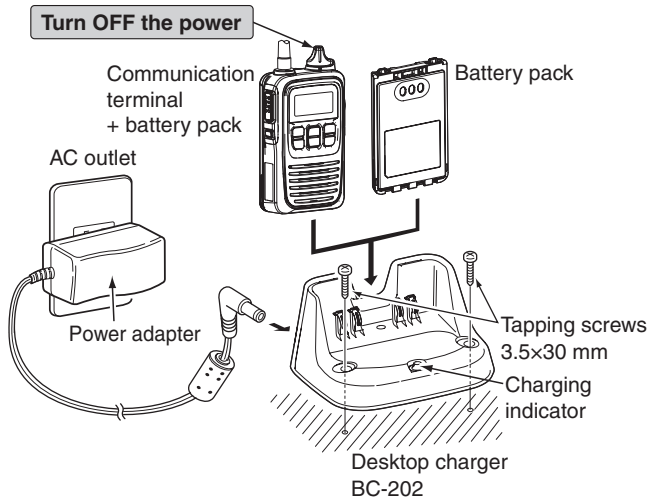

The BC-202 rapidly charges a battery pack.
 Charging time: Approximately 2 hours for the BP-271
 Approximately 3.5 hours for the BP-272

The following item is required.

- A power adapter (A different type, or no power adapter is supplied, depending on the charger versions.)

• **About charging indicator**

- Lights orange: Charging
- Lights green: Charging completed
- Blinks orange: See page 7-2.

Using the BC-211

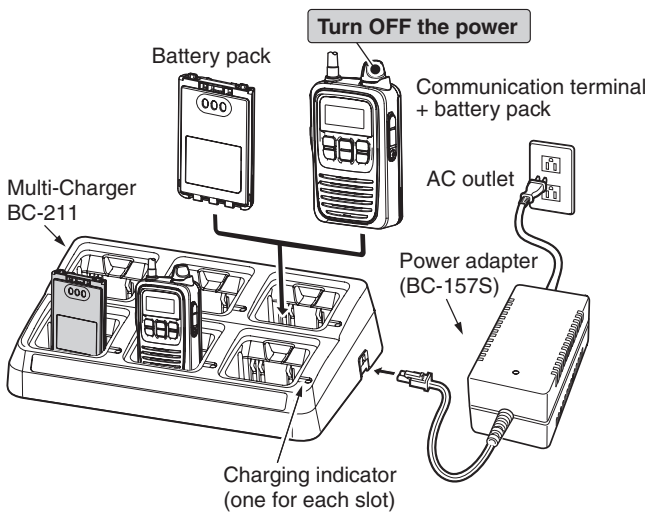

The BC-211 rapidly charges up to 6 battery packs.
 Charging time: Approximately 2 hours for the BP-271
 Approximately 3.5 hours for the BP-272

The following item is required.

- A power adapter (not supplied with some versions.)

• **About charging indicator**

- Lights orange: Charging
- Lights green: Charging completed
- Blinks orange: See page 7-2.

IMPORTANT: Battery charging caution

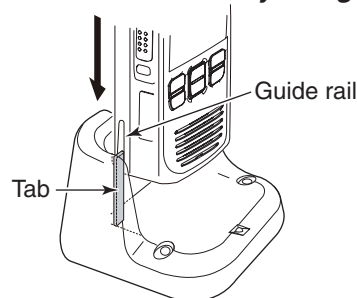

Ensure the guide rails on the battery pack are correctly aligned with the tabs inside the charger.

Battery status indicator

Indicator	Battery status
	The battery charge has sufficient capacity.
	The battery charge is exhausted a little.
	The battery charge is nearing exhaustion. Charging is necessary. (The communication terminal can be operated for a short time.)
	The battery charge is almost exhausted. Charging is necessary. (The communication terminal will quickly become impossible to operate.)

The battery status indicator displays the attached battery pack's (BP-271 or BP-272) remaining battery charge.

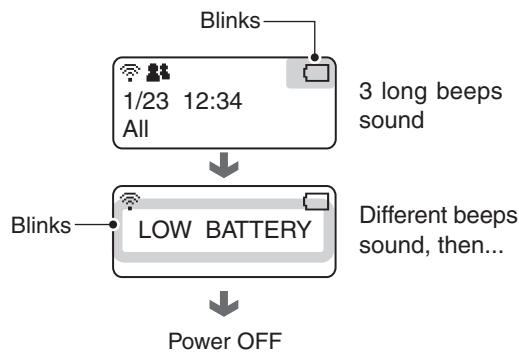

◇ Battery warning beeps

When the battery charge is almost exhausted, the battery status indicator, “”, starts blinking, and warning beeps sound every 30 seconds. Charge the battery pack when the beeps begin to sound.

When “LOW BATTERY” is displayed, the communication terminal power will automatically turn OFF soon.

Battery life

	BP-271	BP-272
Voltage	7.4 V	
Capacity	1150 mAh (minimum) 1200 mAh (typical)	1880 mAh (minimum) 2000 mAh (typical)
Battery life (approximate)	27 hours	40 hours

The approximate battery life (operating time) is shown to the left.

NOTE:
The battery life decreases if the communication terminal is out of a communication area for a long time, causing the terminal to continuously search for an access point (roaming).

• Duty cycle: TX : RX : Standby = 1 : 1 : 8
(based on operating style)

Battery case

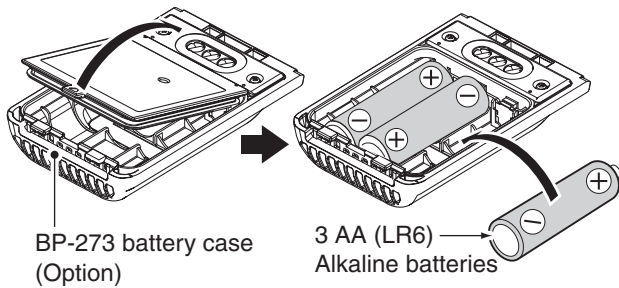

• **Battery life** (approximate)

BP-273: 24 hours*

- Duty cycle: TX : RX : Standby = 1 : 1 : 8
(based on operating style)

*The battery life may differ, depending the installed alkaline batteries.

To use the BP-273 battery case, install three AA (LR6) size alkaline batteries, as described below.

- ① Remove the battery case if it is attached.
- ② Install three AA (LR6) size alkaline batteries.
 - Install only alkaline batteries.
 - Be sure to observe the correct polarity.
- ③ Attach the battery case. (p. 1-3)

/// A built-in step-up converter in the BP-273 increases the voltage to 5.5 V DC.

/// When the BP-273 battery case is used, the battery status indicator cannot display the battery capacity of the alkaline batteries. The battery indicator remains like this: "■". It does not reflect with the true battery capacity.

/// **CAUTION:**

- When installing batteries, make sure they are all the same brand, type and capacity. Also, do not mix new and old batteries together.
- Keep the battery terminals clean. It's a good idea to occasionally clean them.
- Never incinerate used battery cells since the internal battery gas may cause them to rupture.
- Never expose a detached battery case to water. If the battery case gets wet, be sure to wipe it dry before using it.
- Never use batteries whose insulated covering is damaged.
- Remove the alkaline batteries when battery case is not used. Otherwise the installed alkaline batteries will exhausted due to built-in step-up converter.

Section 3

BASIC OPERATION

Turning ON the power	3-2
Adjust audio level.....	3-2
Key lock function.....	3-3

Turning ON the power

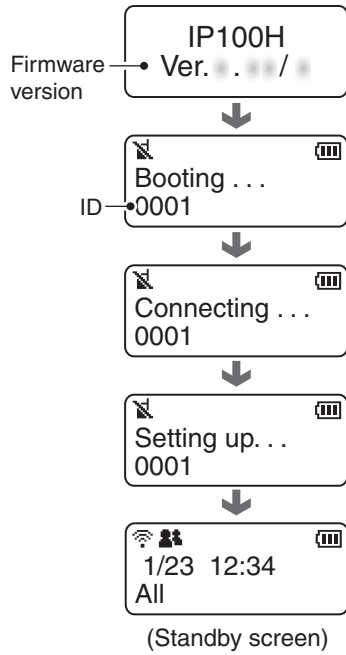
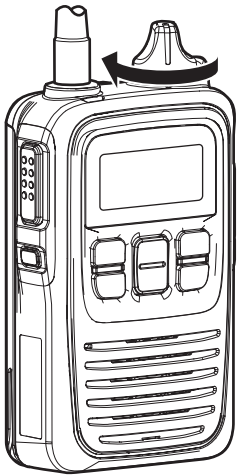

- Rotate [PWR/VOL] to turn ON the power.
 - A click and beep sound.

Attention!

The explanations in this manual are based on the registration to your IP1000C, system controller has been completed.

NOTE: When no standby screen is displayed, ask your system manager.

Adjust audio level

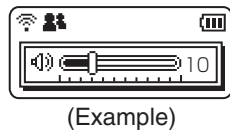
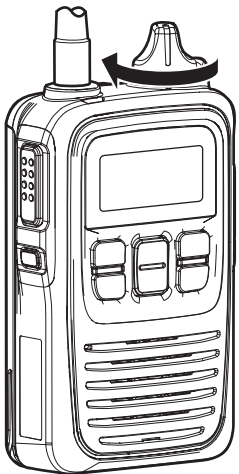

- Rotate [PWR/VOL].
 - A volume level between 0 and 32 is displayed.

Key lock function

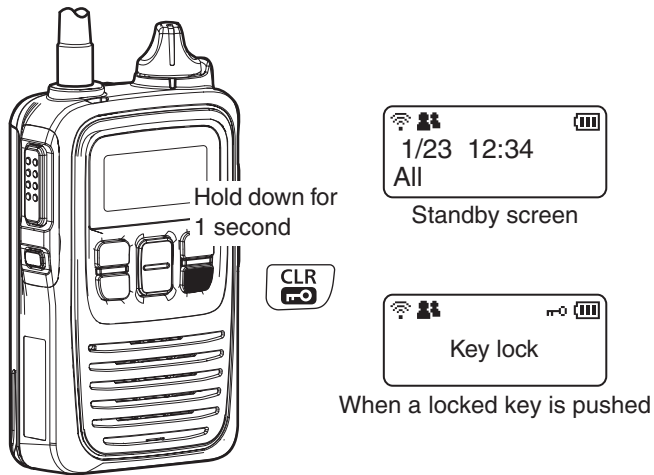

Turn ON to prevent unnecessary function access.

- Hold down [CLR•- [PTT] and [PWR/VOL] can be used while the Key lock function is turned ON.
- When the Key lock function is turned ON and the locked key is pushed, "Key lock" appears.

Calling procedures outline	4-2
Selecting address books, and addresses (ID)	4-3
Selecting messages or statuses	4-4
Voice communication.....	4-5
◇ Individual call.....	4-5
◇ All call	4-5
◇ Group call.....	4-5
◇ Telephone call	4-5
Message Call.....	4-6
◇ To an individual terminal.....	4-6
◇ To all terminals	4-6
◇ To a Group.....	4-6
Using a call history.....	4-7
Status Call	4-8
Erasing all log items.....	4-8
Area Call function.....	4-9

Calling procedures outline

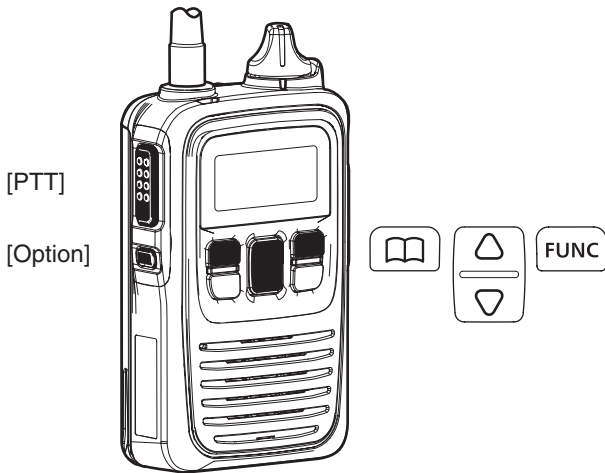

- ① Select a desired address book. (p. 4-3)
 - Push [□] one or more times.
 - Select “All” for all terminals calls, “Group” for group calls, “Individual” for individual terminal calls or “Telephone” for telephone calls.
 - Selectable address books may differ, depending on the IP1000C’s settings.
- ② Select a desired address (ID) or extension number. (p. 4-3)
 - Push [Δ] or [▽] one or more times.
 - Selectable IDs or extension numbers may differ, depending on the IP1000C’s settings.
 - You can select a desired ID or extension number from the call history by pushing [☰]. (p. 4-7)
- ③ If you want to send a message (p. 4-6), or make an area call (p. 4-9), push [FUNC] one or more times.
 - Select “Message” to transmit a message, or “Area Call” for an Area Call.
 - Push [Δ] or [▽] one or more times to select a desired message.
 - Selectable messages may differ, depending on the IP1000C’s setting.
 - When Area Call is selected, push [Δ] or [▽] to select ON.
- ④ Push [PTT] to make a call.
- ⑤ Hold down [PTT], and speak at your normal voice level.
- ⑥ Release [PTT] to listen.
- ⑦ Repeat the steps ⑤ and ⑥ until you finish your conversation.
- ⑧ To hang up a telephone call, push [Option].
 - The function assigned to [Option] may differ, depending on the IP1000C’s settings.
 - Ask your system manager which function is assigned.

For your information

When the VOX function or full-duplex mode is set in the IP1000C, steps ⑤ and ⑥ are not necessary.

When the VOX function is set, speak into the headset microphone to transmit, then stop speaking to listen.

In full-duplex, you can speak and hear the other person at the same times.

Selecting address books, and addresses (ID)

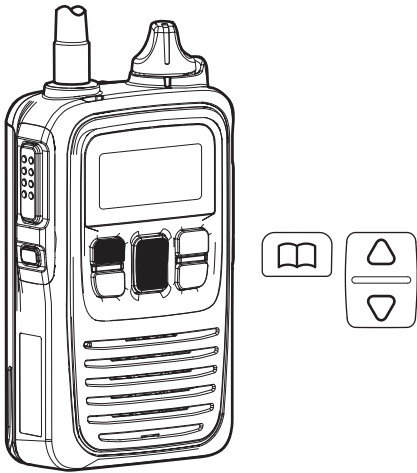

- ① Push [☐] one or more times to select a desired address book.
 - Select “All” for all stations calls, “Group” for group calls, “Individual” for individual station calls or “Telephone” for telephone calls.
 - Selectable address books may differ, depending on the IP1000C's settings.
- ② Push [Δ] or [▽] one or more times to select a desired ID or extension number.
 - Selectable IDs or extension numbers may differ, depending on the IP1000C's settings.

• Address book and address (ID) selection sequence

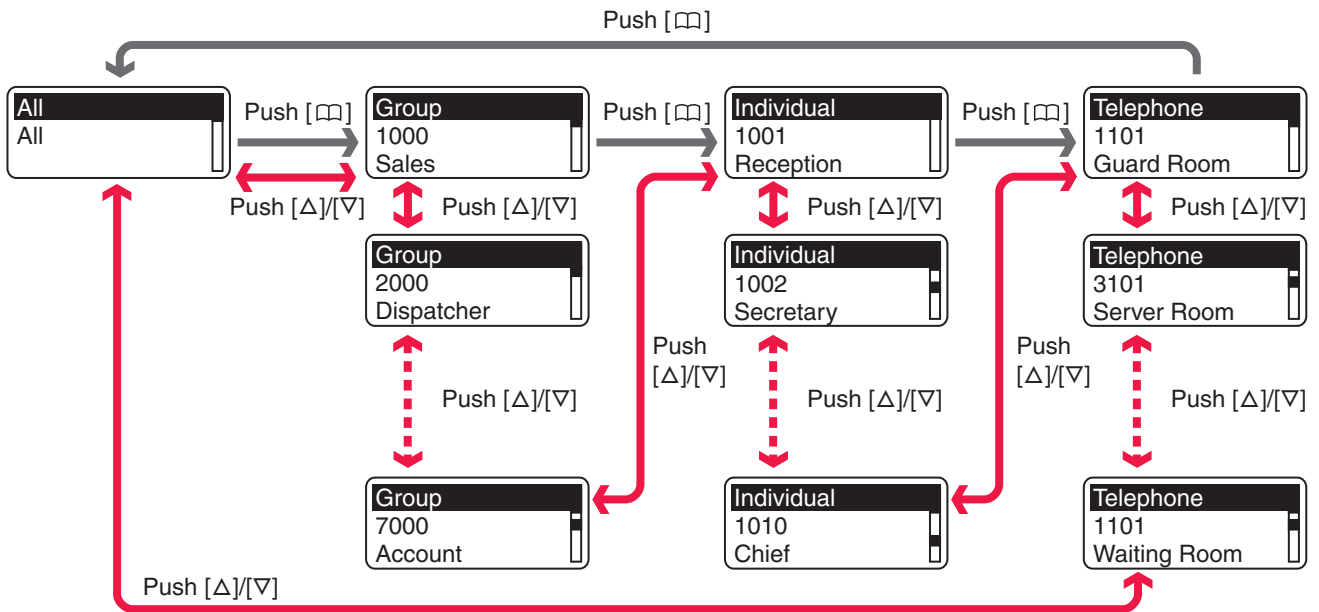

Selecting messages or statuses

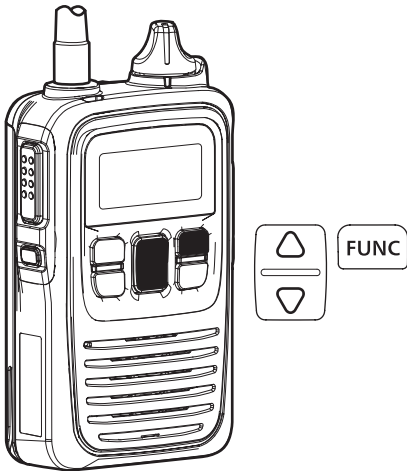

- ① Push [FUNC] one or more times.
 - Select “Message” to transmit messages, or “Status” to transmit statuses.
 - The “Message” or “Status” item may not be selectable, depending on the IP1000C’s settings.
- ② Push [Δ] or [▽] one or more times to select a desired message or status.
 - The selected message or status may scroll, depending on the message length.
 - Selectable message or status may differ, depending on the IP1000C’s settings.

• **Message select screen**

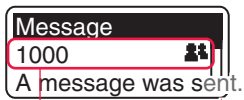

• **Status select screen**

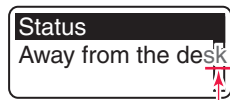

May scroll depending on the message length.

Displays the address (ID) that was selected before you pushed [FUNC].

• **Message, status and the Area Call function selection sequence**

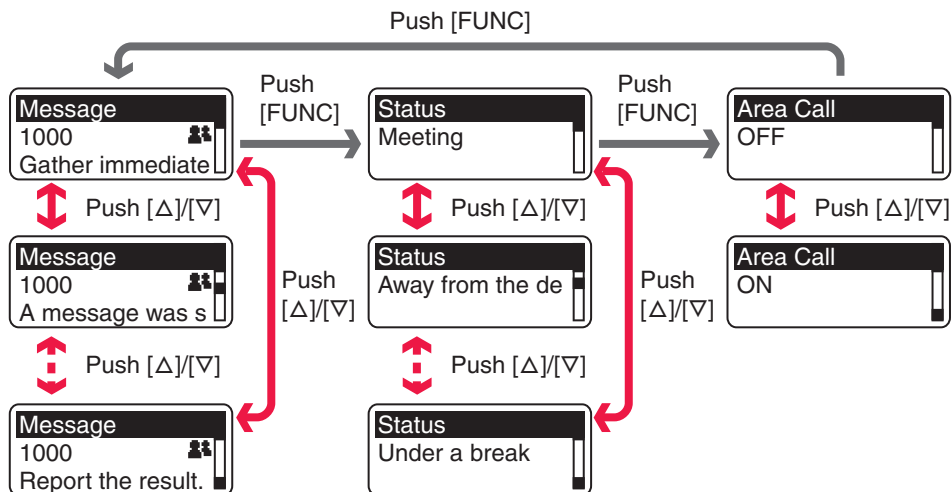

Voice communication

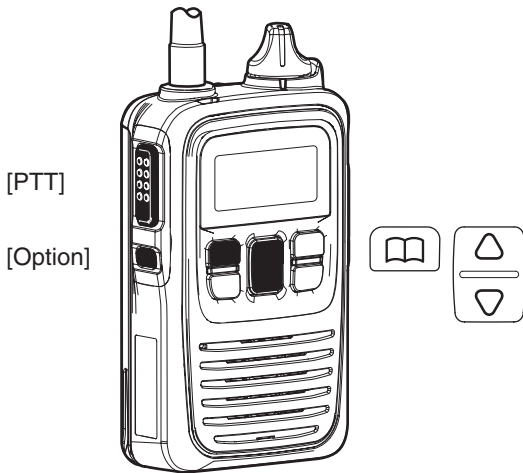

For your reference

Only one terminal can reply to an All or Group call. We recommend you to carefully listen for a reply after you making an All or Group call.

When the VOX function or full-duplex mode is set at the IP1000C, the [PTT] toggling between transmit and listen is not necessary.

When the VOX function is set, speak into the headset microphone to transmit, stop speaking to listen.

In full-duplex, you can speak and hear the other person at the same times.

◇ Individual call

- ① Push [□] one or more times to select “Individual.”
- ② Push [△] or [▽] one or more times to select a desired individual address (ID).
- ③ Push [PTT] to call.
 - When your call is successful, “Connected” may be displayed and beeps may sound, depending on your IP1000C's settings.
- ④ Hold down [PTT] and then speak at your normal voice level.
- ⑤ Release [PTT] to listen.
- ⑥ Repeat the steps ④ and ⑤ until you finish your conversation.

◇ All call

- ① Push [□] one or more times to select “All.”
- ② Push [PTT] to call.
- ③ Hold down [PTT] and say your message at your normal voice level.
- ④ Release [PTT] to listen.

◇ Group call

- ① Push [□] one or more times to select “Group.”
- ② Push [△] or [▽] one or more times to select a desired group address (ID).
- ③ Push [PTT] to call.
- ④ Hold down [PTT] and say your message at your normal voice level.
- ⑤ Release [PTT] to listen.

◇ Telephone call

- ① Push [□] one or more times to select “Telephone.”
- ② Push [△] or [▽] one or more times to select a desired extension number (ID).
- ③ Push [PTT] to call.
- ④ Wait until reply is heard.
- ⑤ After the reply, hold down [PTT] and then speak at your normal voice level.
- ⑥ Release [PTT] to listen.
- ⑦ Repeat the steps ⑤ and ⑥ until you finish your conversation.
- ⑧ To hang up the call, push [Option].

Message Call

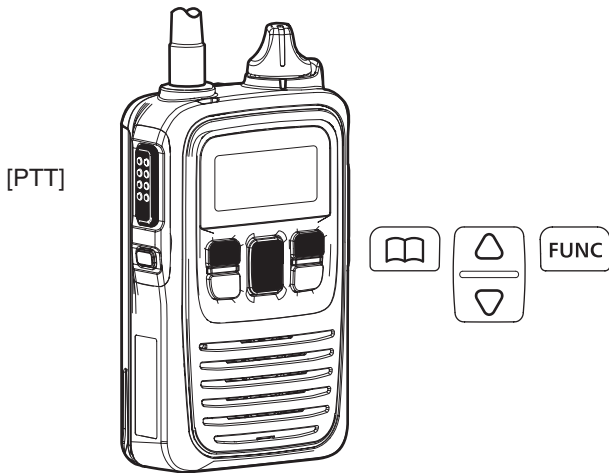

◇ To an individual terminal

- ① Push [□] one or more times to select "Individual."
- ② Push [△] or [▽] one or more times to select a desired individual address (ID).
- ③ Push [FUNC] one or more times to select "Message."
- ④ Push [△] or [▽] one or more times to select a desired message.
 - The selected message may scroll, depending on the message length.
- ⑤ Push [PTT] to call.
 - When your message call is successful, "Successful" may be displayed and beeps may sound, depending on your IP1000C's settings.

◇ To all terminals

- ① Push [□] one or more times to select "All."
- ② Push [FUNC] one or more times to select "Message."
- ③ Push [△] or [▽] one or more times to select a desired message.
 - The selected message may scroll, depending on the message length.
- ④ Push [PTT] to call.
 - When your message call is successful, "Successful" may be displayed and beeps may sound, depending on your IP1000C's settings.

◇ To a Group

- ① Push [□] one or more times to select "Group."
- ② Push [△] or [▽] one or more times to select a desired group address (ID).
- ③ Push [FUNC] one or more times to select "Message."
- ④ Push [△] or [▽] one or more times to select a desired message.
 - The selected message may scroll, depending on the message length.
- ⑤ Push [PTT] to call.
 - When your message call is successful, "Successful" may be displayed and beeps may sound, depending on your IP1000C's settings.

Using a call history

[PTT]

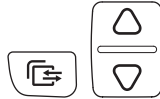
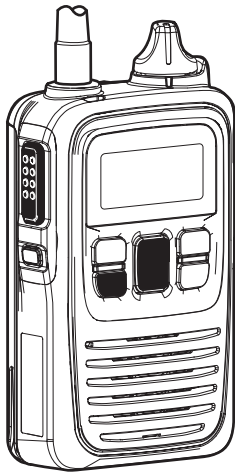

You can make a call using previously transmitted and received call settings.

Up to 10 calls can be stored in each TX log, RX log, TX message log, RX message log, TX telephone log and RX telephone log.

- ① Push [☰] one or more times to select a desired history log.
 - Tx log: Transmitted call
 - Rx log: Received call
 - Tx MSG log: Transmitted message
 - Rx MSG log: Received message
 - Tx TEL log: Transmitted telephone
 - Rx TEL log: Received telephone
- ② Push [Δ] or [∇] one or more times to select a desired log call.
- ③ Push [PTT] to call.

• History selection sequence

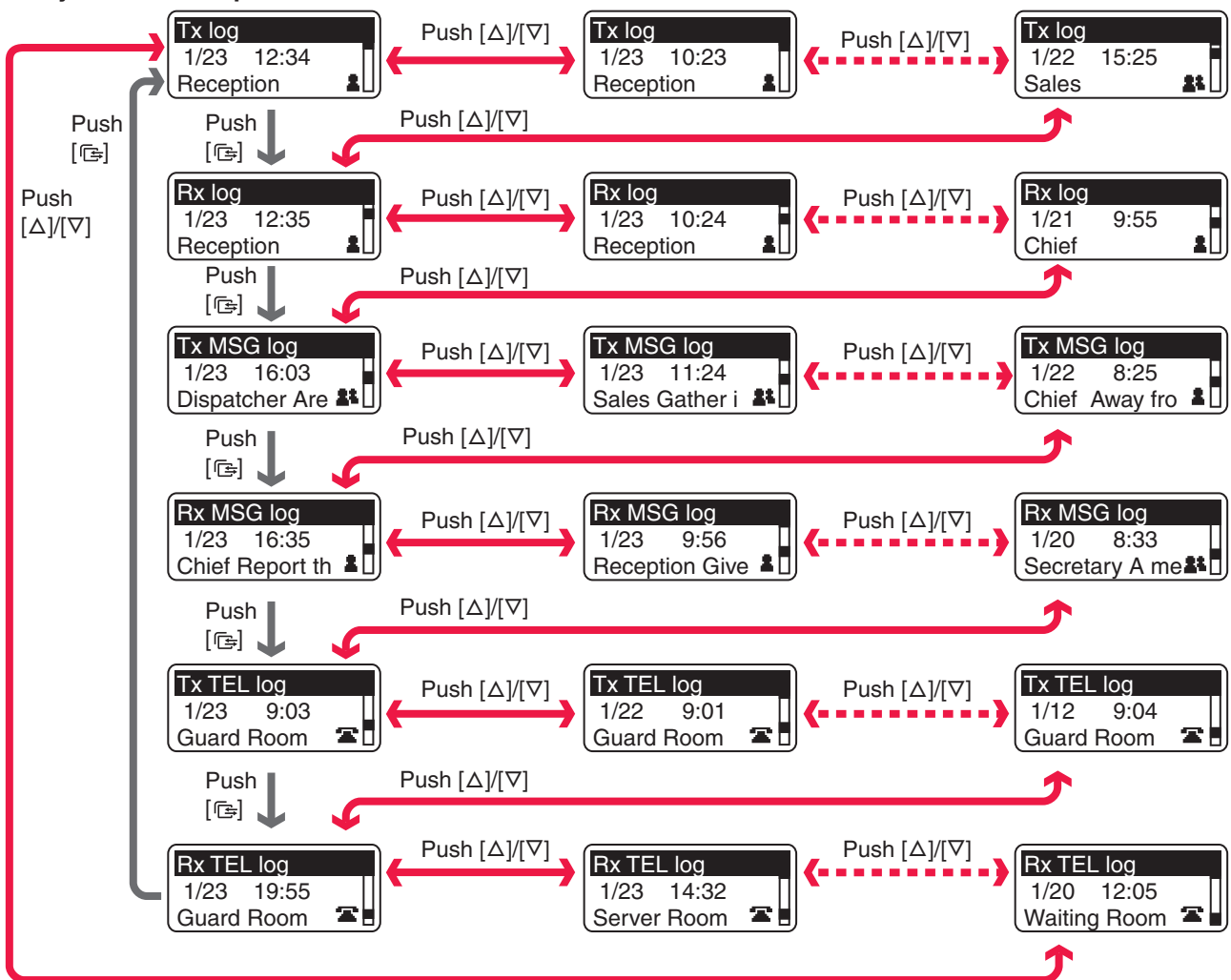

Status Call

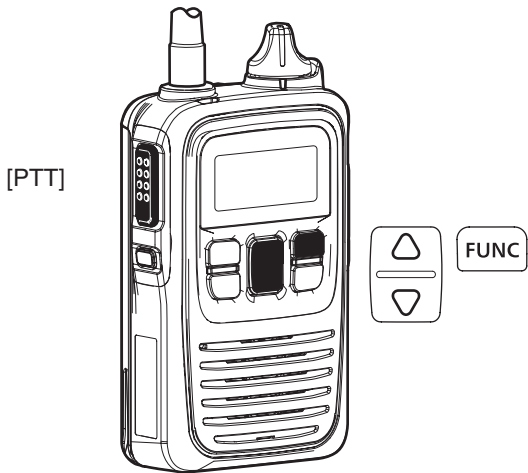

- ① Push [FUNC] one or more times to select “Status.”
- ② Push [Δ] or [▽] one or more times to select a desired status.
 - The selected status may scroll, depending on the message length.
- ③ Push [PTT] to call.
 - When your status call is successful, “Successful” may be displayed and beeps may sound, depending on your IP1000C’s settings.

For your information

A transmitted your status can only be confirmed with your IP1000C system controller or IP100FS remote communicator. Not for an individual IP100H communication terminal.

Erasing all log items

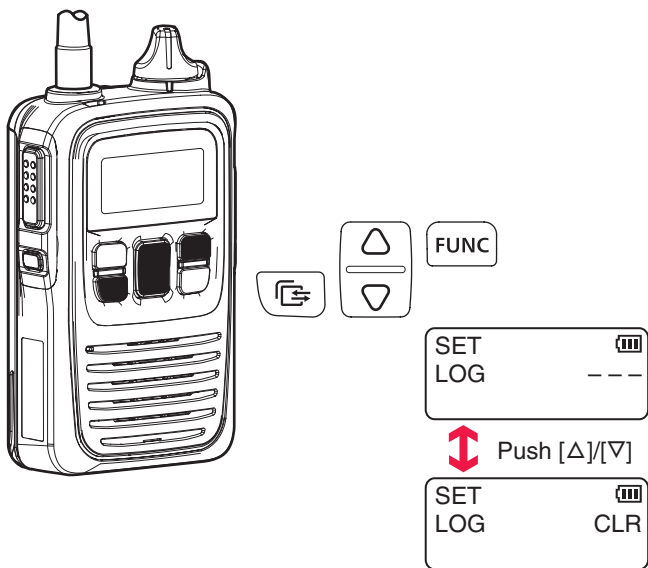

All items in the Tx log, Rx log, Tx MSG log, Rx MSG log, Tx TEL log and Rx TEL log, can be manually erased, if desired.

- ① Turn OFF the communication terminal if it is ON.
- ② While holding down [FUNC], turn ON the power.
 - When “SET” is displayed, release [FUNC].
- ③ Push [Δ] or [▽] one or more times to select “CLR.”
- ④ Push [CLR].
 - “Deleting...” is displayed, then the IP100H automatically reboots.

Area Call function

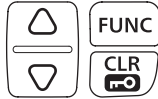
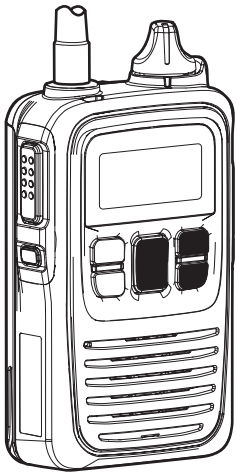

Displayed when the Area Call function is ON.



The Area Call function allows you to call the areas that the selected wireless access points cover.

The Area Call function may or may not be enabled, and the areas you can call depends on your IP1000C's settings.

- ① Push [FUNC] one or more times to select "Area Call."
- ② Push [△] or [▽] to select ON.
- ③ Push [CLR•] to return to the standby screen.
 - "" is displayed.

When an area call is received

"" is displayed for a while even if the area call is set to OFF.

Section 5 OTHER FUNCTIONS

Pocket beep function	5-2
P-Bell function	5-2
About the [Option] switch.....	5-2

Pocket beep function

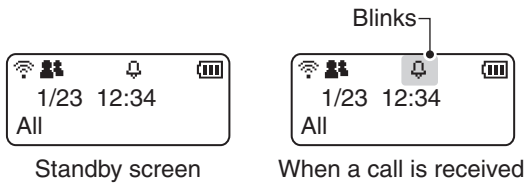

The Pocket beep function sounds beeps and blinks the “” icon to let you know a call is being received.

- This function is set by your IP1000C system controller.

P-Bell function

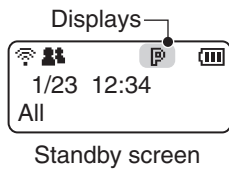

The P-Bell function sounds beeps to let you know a call is being received.

However, you cannot listen to the call until you answer it.

- Push [PTT] to answer the call, then listen to the caller.
- The “” icon is displayed when the P-Bell function is used.
- This function is set by your IP1000C system controller.

About the [Option] switch

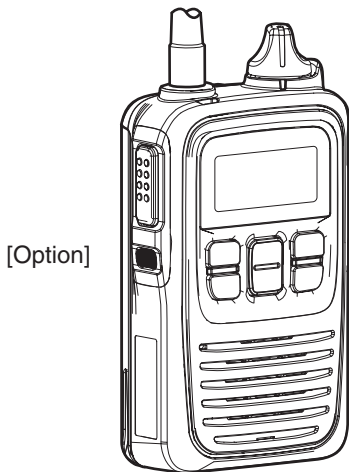

One of the following functions may be assigned to the [Option] switch by your IP1000C system controller.

- Message select: Selects often used messages.
- One touch call select: Selects often used call types with an address.
(either All, Group, Individual or Telephone)
- Clear down: Hangs up a telephone call.

Ask your system manager which function is assigned.

Section 6 OPTIONS

Option list.....	6-2
◇ Battery packs/case.....	6-2
◇ Battery chargers.....	6-2
◇ Others.....	6-2
◇ Headset/Microphones	6-2
Connection.....	6-3
◇ Connectable options.....	6-3

Option list

◇ Battery packs/case

- **BP-271/BP-272** Li-ion BATTERY PACKS
BP-271: 7.4 V/1150 mAh (min.), 1200 mAh (typ.)
BP-272: 7.4 V/1880 mAh (min.), 2000 mAh (typ.)
- **BP-273** BATTERY CASE
For LR6 (AA) × 3 alkaline batteries

◇ Battery chargers

- **BC-202** DESKTOP CHARGER + **BC-123S** AC ADAPTER
- **BC-211** MULTI-CHARGER + **BC-157S** AC ADAPTER
Rapidly charges Li-ion battery pack.
Charging time: Approximately 2 hours for the BP-271
Approximately 3.5 hours for the BP-272

◇ Others

- **LC-181** CARRYING CASE
- **MB-127** BELT CLIP
- **SP-13** EARPHONE + **OPC-2144** ADAPTER CABLE

◇ Headset/Microphones

- **HM-153** EARPHONE MICROPHONE
+ **OPC-2144** ADAPTER CABLE
- **HM-166** EARPHONE MICROPHONE
+ **OPC-2144** ADAPTER CABLE
- **HM-153LS/HM-166LS** EARPHONE MICROPHONES
- **HM-186** SPEAKER-MICROPHONE
+ **OPC-2144** ADAPTER CABLE
- **HM-186LS** SPEAKER-MICROPHONE
For simplex operation
- **HS-85** VOX UNIT + **OPC-2144** ADAPTER CABLE
- **HS-94/HS-95** HEADSETS/**HS-97** THROAT MICROPHONE
+ **OPC-2006LS** ADAPTER CABLE
/ **OPC-2328** PTT SWITCH CABLE
HS-94: Ear-hook type
HS-95: Neck-arm type
OPC-2006LS: For VOX operation

Connection



Be sure to turn power OFF before connecting or disconnecting optional equipment to or from the [P/A] jack.

CAUTION: Attach the jack cover when optional equipment is not used.

◇ Connectable options

HM-153LS/HM-153*1
EARPHONE MICROPHONE

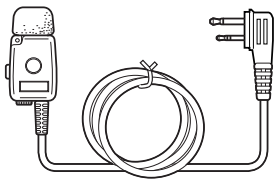

HM-153LS

HM-166LS/HM-166*1
EARPHONE MICROPHONE

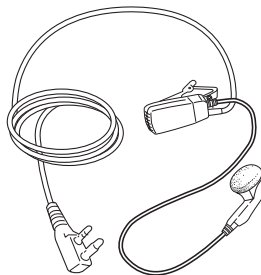

HM-166LS

HM-186LS/HM-186*1, *2
SPEAKER-MICROPHONE

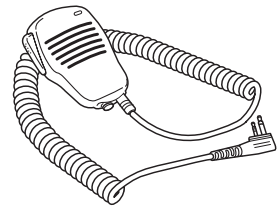

HM-186LS

HS-85*1, †1
VOX UNIT



HS-94*3, *4, †2
HEADSET (Ear-hook type)

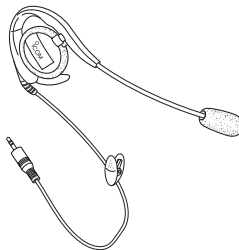

HS-95*3, *4, †2
HEADSET (Neck-arm type)

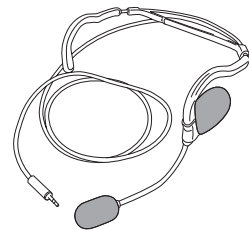

HS-97*3, *4, †2
THROAT MICROPHONE

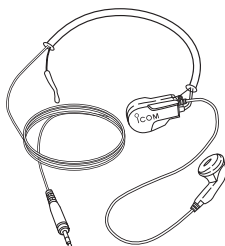

SP-13*1
EARPHONE

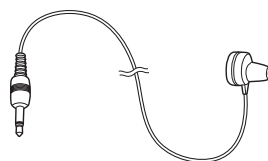

*1 OPC-2144 is required.

*2 For simplex operation

*3 OPC-2006LS is required for VOX operation.

*4 OPC-2328 is required for PTT switch operation.

†1 Disables the VOX function in your IP1000C setting.

†2 To use the VOX function, enables the VOX function in your IP1000C setting.



Section 7 FOR YOUR REFERENCE

Troubleshooting.....	7-2
Specifications	7-3
◇ IP100H	7-3
◇ BC-202 DESKTOP CHARGER	7-3
◇ BC-211 MULTI-CHARGER	7-3

Troubleshooting

The following chart is designed to help you correct problems which are not equipment malfunctions.

If you are unable to locate the cause of a problem, or solve it through the use of this chart, contact your nearest Icom Dealer or Service Center.

PROBLEM	POSSIBLE CAUSE	SOLUTION	REF.
No power comes ON.	<ul style="list-style-type: none"> The battery charge is exhausted. Loose connection of the battery pack (case). 	<ul style="list-style-type: none"> Charge the battery pack, or replace the batteries. Clean battery pack (case) terminals. 	pp. 2-4 2-6 –
No sound comes from the speaker.	<ul style="list-style-type: none"> Volume level is too low. 	<ul style="list-style-type: none"> Rotate [PWR/VOL] to adjust to a desired level. 	p. 3-2
No reply is received	<ul style="list-style-type: none"> Too far from an access point. The “” icon blinks. The operator is away from the terminal, or the terminal is turned OFF. 	<ul style="list-style-type: none"> Move your location, then try again. Wait until the operator is back, or ask system manager about the status. 	– –
“Key lock” is displayed when a key is pushed	<ul style="list-style-type: none"> The Key Lock function is turned ON. 	<ul style="list-style-type: none"> Hold down [CLR•] for 1 second to turn the Key Lock function OFF. 	p. 3-3
Cannot charge the battery pack completely	<ul style="list-style-type: none"> The communication terminal power is ON. 	<ul style="list-style-type: none"> Turn OFF the power. 	p. 2-4
The charging indicator blinks orange, or alternately blinks orange and green	<ul style="list-style-type: none"> The battery pack is not properly inserted. Charging the battery pack outside of the chargeable temperature range. Loose connection of charging terminals. The communication terminal power is ON. 	<ul style="list-style-type: none"> Insert the battery pack properly. Charge the battery pack in the chargeable temperature range: BC-202: 0°C to 40°C (+32°F to +104°F) BC-211: 10°C to 40°C (+50°F to +104°F) Clean the charging terminals. Turn OFF the power. 	p. 2-4 p. 2-3 – p. 2-4
The “  ” icon blinks, or “Connecting...” is displayed (standby screen won't be displayed)	<ul style="list-style-type: none"> SSID Broadcast function is ON in an access point (when 5 GHz band is used). Too far from an access point. Access point power is OFF. 	<ul style="list-style-type: none"> Ask your system manager about the access point settings. Move your location, then try again. Turn ON the access point power. 	– – –

Specifications

◇ IP100H

- **Power supply requirement:**
Icom BP-271, BP-272 battery pack or BP-273 battery case
- **Current drain:**
Less than 150 mA average
(Tx: 100 mA, Rx: 150 mA, standby: 50 mA)
- **Usable temperature range:**
-10°C to +60°C (+14°F to +140°F)
- **Dimensions:** 58(W) × 95(H) × 26.4(D) mm
(2.3(W) × 3.7(H) × 1.0(D) inches)
(projections are not included)
- **Weight:** Approximately 205 g (7.2 oz)
(with antenna and BP-271)
- **Wireless LAN standard:**
IEEE802.11 n/a/b/g
- **Authentication and Encryption:**
WEP (64/128 bit),
WPA-PSK (TKIP/AES),
WPA2-PSK (TKIP/AES)
- **Protocol:** TCP/IP
- **Communication range:** (Approximate)

Frequency band	Internal antenna	External antenna
2.4 GHz band	90 m (295 ft)	160 m (525 ft)
5 GHz band		190 m (623 ft)

- **Audio codec:** G.711 μ -law (64 kbps)
- **Audio output power:**
Internal speaker
More than 400 mW
(at 10% distortion into a 16 Ω load)
External speaker
More than 200mW
(at 10% distortion into an 8 Ω load)
- **Audio output impedance:**
Internal speaker
16 Ω
External speaker
8 Ω

◇ BC-202 DESKTOP CHARGER

- **Power supply requirement:**
12 to 16 V DC or the specified Icom power adapter
- **Charging temperature range:**
0°C to +40°C (+32°F to +104°F)
- **Weight:** Approximately 104 g; 3.7 oz
(without power adapter)
- **Dimensions:** 88(W) × 72.6(H) × 46.5(D) mm
(3.5(W) × 2.9(H) × 1.8(D) inches)
(projections are not included)

◇ BC-211 MULTI-CHARGER

- **Power supply requirement:**
12 to 16 V DC or the specified Icom power adapter
- **Charging temperature range:**
10°C to +40°C (+50°F to +104°F)
- **Weight:** Approximately 1200 g; 2.6 lb
(without power adapter)
- **Dimensions:** 303.2(W) × 78.2(H) × 179.7(D) mm
(11.9(W) × 3.1(D) × 7.1(H) inches)
(projections are not included)

Count on us!

